

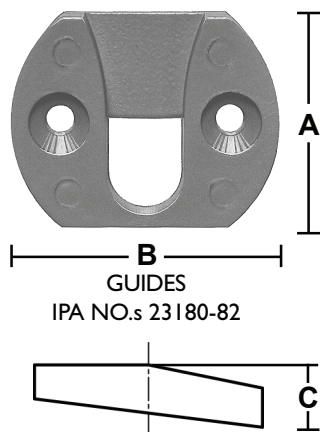

ACCESSORIES FOR ROLLER BOLT ESPAGNOLETTES

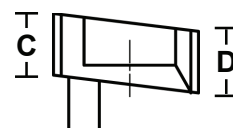

ORDERING NO.										
IPA NO.	MATERIAL	SURFACE		STANDARD PACKING IN BOXES OF 10 PIECES	STANDARD PACKING IN BOXES OF 100 PIECES	A MM	B MM	C MM	SCREW	APPROX. WEIGHT KG/EACH
	PLASTIC	WITHOUT SPECIFICATION	WHITE							
23180	9	0	56	1	2	38	30	8	4,0	0,005
23181	9	0	56	1	2	38	30	11	4,0	0,006
23182	9	0	56	1	-	38	30	13	4,0	0,008

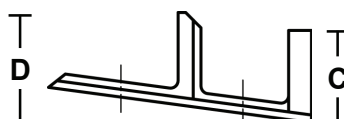
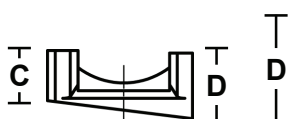
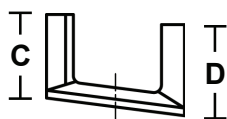
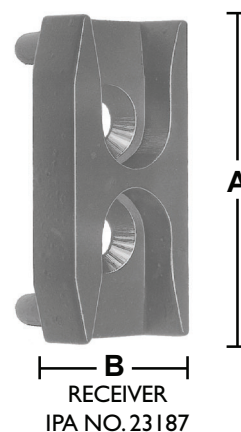
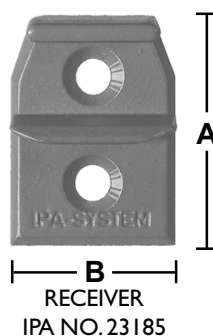
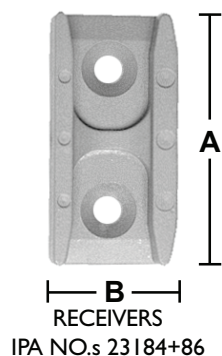
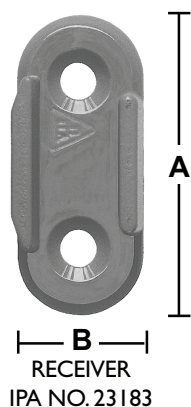

ORDERING NO.										
IPA NO.	MATERIAL	SURFACE		STANDARD PACKING IN BOXES OF 20 PIECES	A MM	B MM	C MM	D MM	SCREW	APPROX. WEIGHT KG/EACH
	STEEL	WITHOUT SPECIFICATION	ELECTROPLATED							
23183	1	0	21	1	43	18	11	12	4,0	0,016
23184	1	0	21	1	39	19	6,5	8,5	4,0	0,022
23185	1	0	21	1	25	35	10	12	4,0	0,015
23186	1	0	21	1	39	19	8,5	10,5	4,0	0,022
23187	1	0	21	1	39	20	8	8	4,0	0,022