

## Nu Mail Letterplate



### Features

- **Midrail and panel letterplate options to suit doors 20mm-80mm thick**  
Suits a range of door thickness
- **Fully colour matched metal letterplate**  
Quality and durability you can see and feel
- **Anti-snap flap opens to 180° with fully sprung return**  
Easier to operate, no broken flaps, even with Sunday papers
- **12" letterplate with a 10" aperture**  
Meets Royal Mail standards, will easily take A4 size post
- **Fully Weather Sealed (with rubber gasket)\***  
No draft, no rain water
- **Secure through fixing ensures letterplate can only be removed from the inside of the house**  
Prevents burglars gaining access to the cylinder internally
- **Can be through fixed or face fixed**  
Flexible according to fabricator preference
- **Outstanding acoustic insulation\***  
Perfect for flats, or houses near busy roads
- **Supplied with screw fixings**  
Everything needed for installation included
- **Secured by Design**  
Additional peace of mind

\*For best acoustic and weather performance we recommend installing the product with a rubber gasket

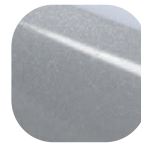

Silver



Black



White

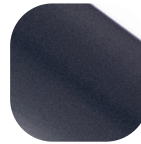

Anthracite Grey



Hardex Chrome



Hardex Satin

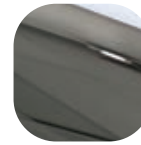

Hardex Bronze

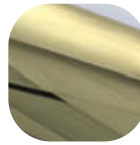

Hardex Gold

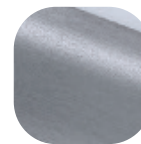

Hardex Graphite



Hardex Rose

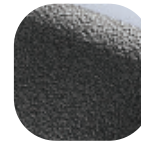

Antique Black



Hardex Pewter

## Nu Mail Letterplate

### Ordering Details

#### Product

#### Nu Mail Letterplate

Finish	Part No.			
	Panel 68 (20-40)	Midrail 68 (40-80)	Panel 76 (20-40)	Midrail 76 (40-80)
Hardex Chrome	3C301	3C101	3C201	3C001
Hardex Satin	3C302	3C102	3C202	3C002
Hardex Bronze	3C303	3C103	3C203	3C003
Hardex Gold	3C305	3C105	3C205	3C005
Hardex Graphite	3C311	3C111	3C211	3C018
Hardex Pewter	-	-	-	3C011
Hardex Rose	-	-	-	DLPNMHRM176
Antique Black	3C306	3C106	3C206	3C006
Anthracite Grey	-	3C112	-	-
White	3C300	3C100	3C200	3C000
Black	3C308	3C108	3C208	3C008
Silver	3C309	-	3C209	3C009
*Easy Fit Rubber Drip Gasket	9B000			

### Technical Information

#### Corrosion resistance

Meets the requirements of BS EN 1670:2007 Grade 5 (480 hours)

#### Operation

Flap cycle tested to 30,000 cycles

Conforms to the requirements of BS EN 13724: 2002

#### Performance

Tested as part of a complete door set that successfully achieved PAS 23 (rubber gasket fitted). Tested as part of a complete door set that successfully achieved PAS 24. 30 minute fire test to BS 476: Part 20/22: 1987

#### Screws

Midrail version includes 2 x M5 x 45mm machine screws, 2 x M5 x 63mm machine screw, 2 x M5 x 74mm machine screws and 2 screw guides

Panel version includes 2 x M5 x 28mm machine screws and 2 screw guides

### Material Specification

Frame and Flap: High quality Zinc

Coatings: Hardex Chrome, Hardex Satin, Hardex Bronze, Hardex Gold, Hardex Graphite, Hardex Pewter, Hardex Rose, Antique Black, Anthracite Grey, White, Black and Silver.

### Maintenance

For continued protection of the quality finish and appearance, Fab&Fix advise routine cleaning of all our external hardware. Moving parts should also be lightly lubricated at least twice a year. This procedure is particularly essential if products are used within a 25-mile radius of coastal areas or close proximity to building sites or large industrial areas, where more frequent cleaning may be required to prevent the accumulation of corrosive contaminants.

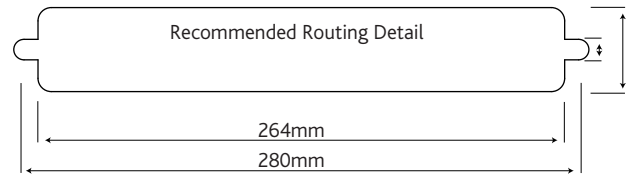
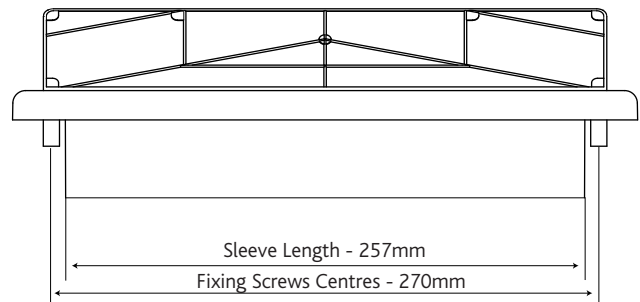
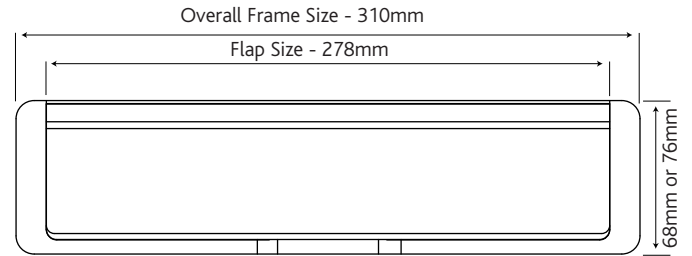

Panel Sleeve Set  
20mm-40mm

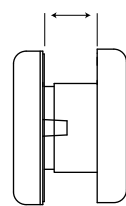

Midrail Sleeve Set  
40mm-80mm

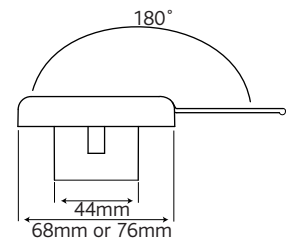
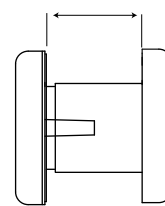

Fixing Screws Provided

All dimensions are in mm and are nominal.  
Fab&Fix reserves the right to change specification without notice  
It is the responsibility of the door manufacturer to ensure that the finished product meets any required safety and performance specification.

### Packaging

#### Nu Mail Letterplate

Individually boxed with fixings and care instructions.  
15 letterplates in an outer box.