

TOP VIEW

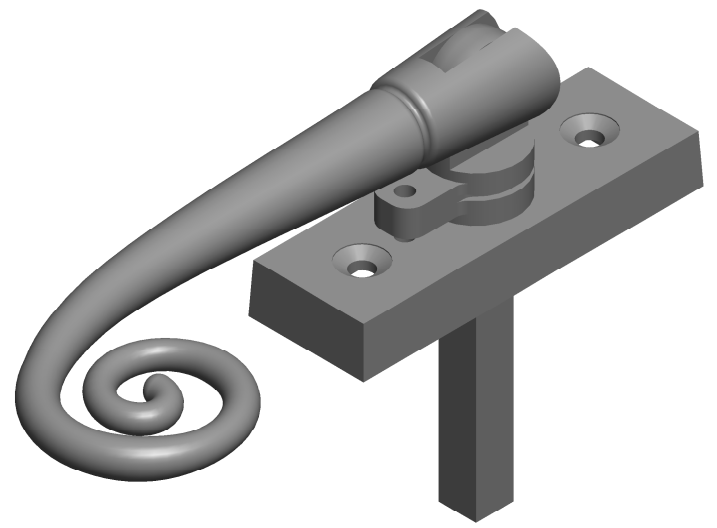

3D VIEW

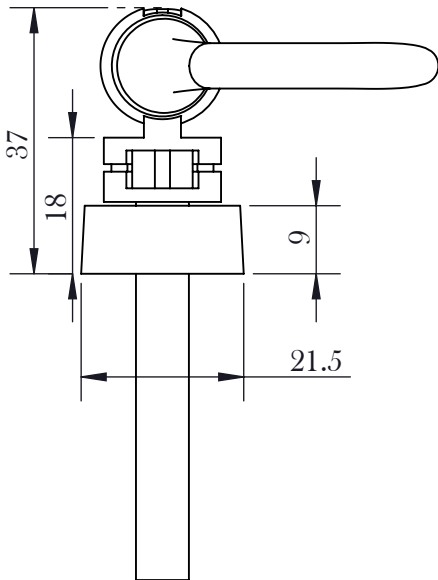

FRONT VIEW

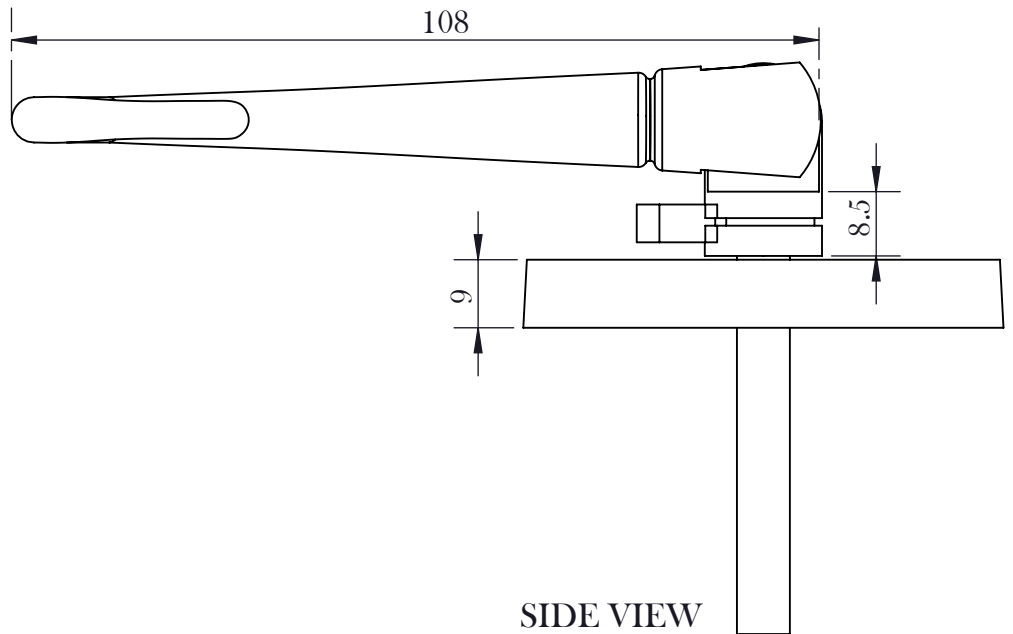

SIDE VIEW

NOTES:- ALL DIMS. ARE IN MM.

DIMENSIONS ARE IN MM
 TOLERANCES:- ± 1 MM
 ANGULAR MACH \pm BEND \pm

ITEM CODE:- ESP233

Name	Sign.	Date
DRAW.		20-10-2021
CHECKED		
MAG. APPR.		
COMMENT		
SCALE	N. T. S.	
MATERIAL-		
DRG. No. :-01		